

Effect of Voltage on the Properties of $\text{Cu}_2\text{ZnSnS}_4$ Solar Cells by Electrochemical Deposition

Husna Hanifa¹, Eka Cahya Prima^{2,*}, Andhy Setiawan¹, Endi Suhendi¹, Brian Yulianto^{3,4}

* ekacahyaprima@upi.edu

¹ Department of Physics, Faculty of Mathematics and Science Education, Universitas Pendidikan Indonesia, 40154, Bandung, Indonesia

² Department of Science Education, Faculty of Mathematics and Science Education, Universitas Pendidikan Indonesia, 40154, Bandung, Indonesia

³ Department of Engineering Physics, Faculty of Industrial Engineering, Institut Teknologi Bandung, 40132, Bandung, Indonesia

⁴ Research Center for Nanosciences and Nanotechnology (RCNN), Institut Teknologi Bandung, 40132, Bandung, Indonesia

Received: December 2022

Revised: September 2023

Accepted: September 2023

DOI: 10.22068/ijmse.3016

Abstract: In the third generation of solar cells, cheaper absorbent layers such as $\text{Cu}_2\text{ZnSnS}_4$ (CZTS) have been developed with specifications similar to $\text{Cu}_2\text{InGaS}_4$ (CIGS). This CZTS material is known as a material with good structural and optical properties where the CZTS material has a series of atoms bonded to each other to form a kesterite or stannite crystal arrangement. In its use as an absorbent layer for solar cells, CZTS material is synthesized using the electrochemical deposition method. In this electrochemical deposition technique, an electrical circuit will be connected to the electrode and inserted into the electrolyte. Several voltage variations from 1 volt to 5 volts will be applied to the electrical circuit, triggering ions from the precipitating material in the electrolyte to stick to one of the electrodes. Variation of deposition voltage was carried out to determine the effect of deposition stress on the electrochemical deposition method on the characteristics of the CZTS absorbent layer. The characterizations used are X-ray diffraction (XRD), UV-Vis Spectrometry, and I-V meter. XRD results show that the resulting crystal size is getting smaller with greater deposition voltage around 6.07- 7.27 nm. The optical absorption results show that the CZTS absorber layer is sensitive at low wavelengths, around 300– 480 m, with Light Harvesting Efficiency (LHE) ranging from 13.3- 24.75%. The band gap energy values obtained ranged from 1.4 to 1.48 eV. The cell efficiency test results show an excellent efficiency value in reference ranges from 2.56- 8.77%. These results indicate that the deposition voltage affects the characteristics of the CZTS absorbent layer for solar cell applications.

Keywords: $\text{Cu}_2\text{ZnSnS}_4$ (CZTS), Electrochemical Deposition, Voltage Deposition, Solar Cell.

1. INTRODUCTION

CZTS material is known as a material with good structural and optical properties where the CZTS material has a series of atoms bonded to each other to form a kesterite or stannite crystal arrangement. Besides having non-toxic properties, CZTS material is also considered a promising material because it has an almost optimal gap value of 1.4~1.6 eV, a significant absorption coefficient (10^4 cm^{-1}) and a theoretical power conversion limit. Efficiency by 32.2% (Islam et al., 2021).

In its use as an absorbent layer, it has been found that the CZTS material has high efficiency with the CZTS absorbent layer using a Cu-poor Zn-rich composition [1-3]. Using CZTS material as a porous layer can overcome the problem of material limitations because it can be produced

with thinner layers [4]. Replacing materials that are not environmentally friendly and have abundant elements [5, 6].

CZTS materials have various methods that can be used to synthesize absorbent layers—divided into physical and solution Processes. For physical process, there are methods of Electrochemical deposition [7], Vacuum/Non Vacuum deposition [8-10], Electron beam evaporation [11], Magnetron sputtering [12], Spray Pyrolysis [13], and pulsed laser deposition [14] as for alkaline solutions, such as the Sol-gel method [15] and Thermal deposition [16].

This research was conducted using the electrochemical deposition method. The electrochemical deposition method is a method that oxidizes and reduces one material to accumulate in another material. In this electrochemical deposition method, an electrical

circuit will be connected to the electrode and inserted into the electrolyte [17-19]. A certain amount of voltage will be applied to the electrical circuit, which will then trigger ions from the depositional material in the electrolyte to stick to one of the electrodes. Ions attached to these electrodes will later become a thin layer for solar cell applications.

The advantage of this electrochemical deposition method is that it has an easy route because it utilizes the transfer of electrolyte ions to the electrodes only with the help of an electric voltage. It uses non-vacuum technology and works at room temperature, using low-quality, non-toxic solvents and reagents [20]. The layer produced by this method shows compact and smooth morphological properties so that it is by its efficiency requirements as an absorbent layer [21]. This method also makes it possible to synthesize materials in broad and flexible layers to become an advantage in industrial processes.

The appropriate sulfurization temperature and Cu-poor Zn-rich composition in the electrochemical deposition method can avoid the appearance of a secondary phase affecting the efficiency [8, 22-24]. After temperature and composition, another influential variable is deposition stress. Where electrochemical deposition was carried out at 1-5 volts. Fig. 1 shows the CZTS surface prepared by electrochemical deposition at -0.85 V [19], 1.05

V [18], and 7.2 V [25], our sample at 2.0 V (d), our sample at 4.0 V (e), and cross-section at 2.0 V (f). The surface shows a significant enough difference.

The concept of ion transfer from the CZTS electrolyte material is triggered by applying a specific voltage to the electrical circuit. This makes the settling rate faster if a larger settling stress is used for the same time duration. Thus, the resulting CZTS absorbent layer may be thicker and affect the morphological and optical characteristics of the resulting layer. Supporting the good CZTS material properties, these characteristics are expected to show the ideal stress size to produce more optimal efficiency values. This work contributes to optimizing the effect of voltage variation on the properties of $\text{Cu}_2\text{ZnSnS}_4$ solar cells by electrochemical deposition. This work also achieved the highest reported cell performance via $\text{Cu}_2\text{ZnSnS}_4$ solar cell prepared via electrochemical deposition and non-vacuum method.

2. EXPERIMENTAL PROCEDURES

All chemical materials are obtained from Merck. The research began with the preparation of an electrolyte solution containing 6.35 mmol $\text{CuO}_4\text{C}_4\text{H}_6\cdot\text{H}_2\text{O}$; 4.1 mmol Zn $(\text{CH}_3\text{CO}^\ominus\text{O})_2\cdot 2\text{H}_2\text{O}$; 3.3 mmol $\text{SnCl}_2\cdot 2\text{H}_2\text{O}$; and 6.6 mmol $\text{Na}_2\text{S}_2\text{O}_3$.

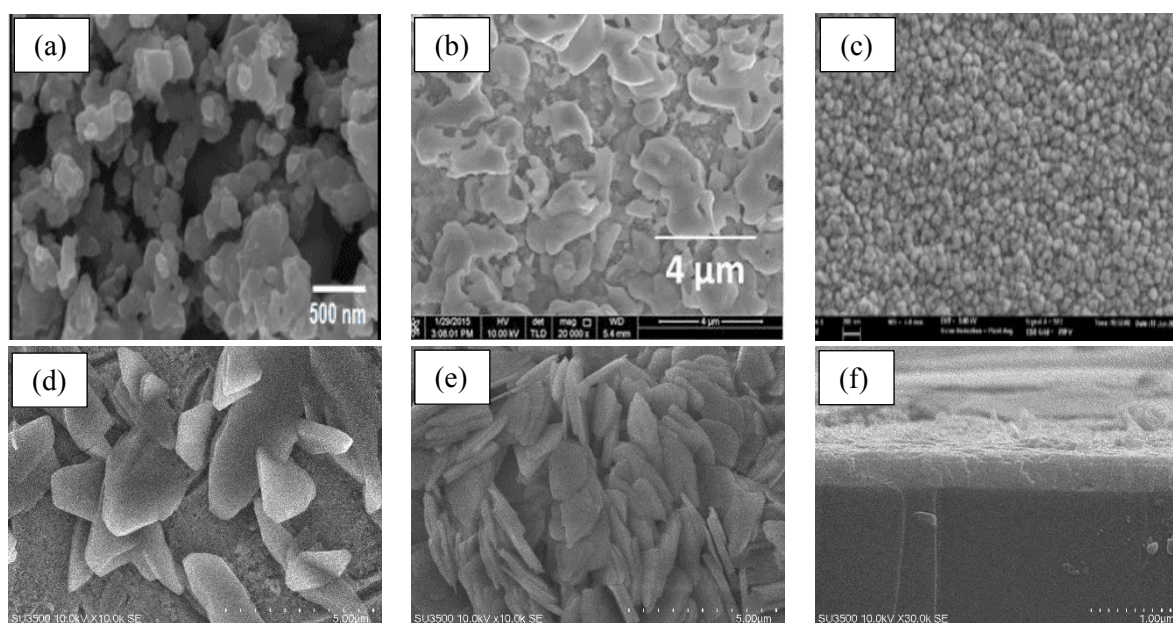

Fig. 1. CZTS surface prepared by electrochemical deposition at -0.85 V (a), 1.05 V (b), 7.2 V (c), our sample at 2.0 V (d), our sample at 4.0 V (e), and cross section at 2.0 V (f)

It was deposited for 30 minutes using ITO as the working electrode, AgCl as the reference electrode, and platinum wire as the counter electrode. Given a deposition voltage variation of 1 V-5 V. The layer deposited on the ITO substrate is then sulfurized using 0.005 mmol sulfur powder. The sample was put into the furnace, and the sulfurization process was carried out at a temperature of 500°C for 4 hours. After the sulfurization process, the sample is cooled to room temperature, as seen in Fig. 2.



Fig. 2. Electrochemical deposition on ITO (before and after sulfurization– top-bottom)

The solar cell layers based on the CZTS absorber layer are arranged in a sandwich configuration, including transparent conductive glass (ITO), CZTS layer, quasi-solid electrolyte, rGO as the counter electrode, and polymer resin adhesive system illustrated in Fig. 3. Solar cells are composed of Indium Tin Oxide which functions as a back contact. It collects the charge intended as an electrode (Orgassa et al., 2003)). The cell assembling procedure followed our previous reports [9, 10, 26, 27].

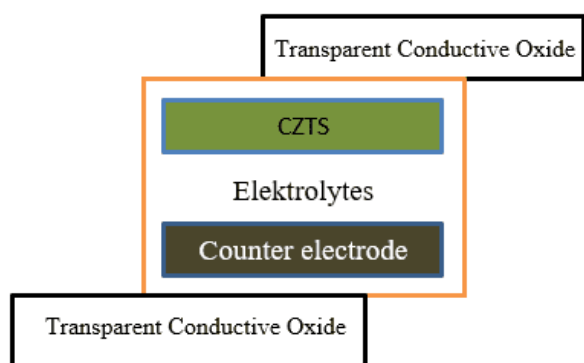

Fig. 3. CZTS sandwich configuration design

The samples were then characterized using UV-Vis and XRD and tested for solar cell performance using I-V. To obtain the band gap energy, a Tauc plot is used by interpolating the linear area of the curve $(ah\nu)^2$ so that it intersects the photon energy axis. The intersection of the

photon energy axes is then defined as the band gap energy of the absorbing layer. Solar cell performance testing was carried out using a standard AM1.5 Solar Simulator with 100 mW/cm² light intensity, and CZTS absorber layer area 5 cm². Analysis is carried out by comparing variations in efficiency values.

3. RESULTS AND DISCUSSIONS

3.1. Characterization of the CZTS Absorber Layer

A test was carried out to determine the crystal structure of the CZTS absorber layer using X-ray Diffraction (XRD). As shown in Fig. 4. The diffraction pattern produced by each sample is almost the same. The diffraction peaks produced in each sample were (110), (112), (004), (006), (224), (206); (110), (112), (020), (006); (110), (112), (020), (105), (006), (206); and (101), (112), (112), (103), (020), (006), (206). The peak indicates the formation of CZTS kesterite [28]. Based on the number of phases that appear, the 5 V sample shows the formation of more CZTS kesterites.

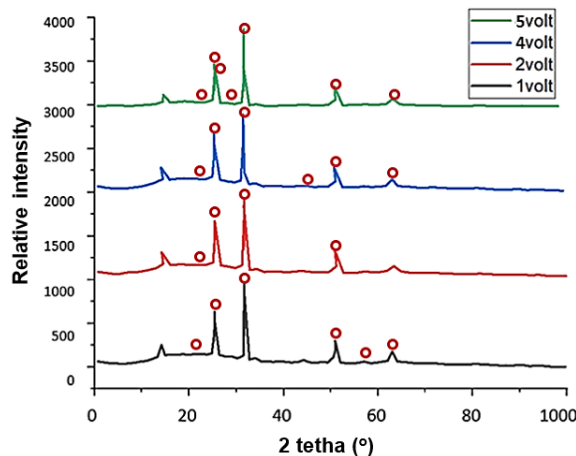

Fig. 4. X-Ray diffraction pattern of the CZTS by Electrochemical Deposition

From the XRD characterization, it can be seen the approximate crystal size using the Scherrer formula. The crystal size in the 1 V to 4 V sample is known to be more significant than in the 5 V sample. The annealing temperature used in each sample was 500°C. That at that temperature produces good crystallinity and an increase in grain size [29, 30]. However, after using the same annealing temperature, it can be seen in Table 1. That there are still differences in crystal size at the

5V deposition voltage. This analysis shows the effect of the magnitude of the given deposition stress on the crystal size.

Determine the optical characterization of the CZTS absorbing layer obtained from the Uv-Vis test. The results of the Uv-Vis test were observed to determine the absorbance of the CZTS absorbing layer. Fig. 5. Shows the absorption spectrum of each sample of the CZTS absorbent layer in the 300-700 nm range. From our previous experiment (Gema, 2020), the quantitative mass percentage of the kesterite phase and the secondary phases that can be seen in Fig. 6 shows Cu_2S , SnS_2 , SnS , and ZnS were detected as secondary phases formed in the CZTS layer.

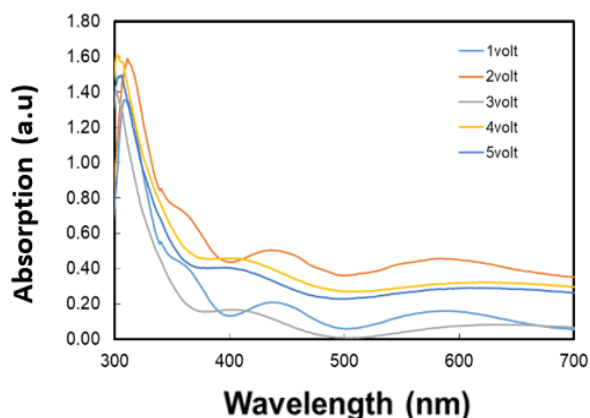

Fig. 5. Absorbance spectrum of CZTS absorbent layer against wavelength

By getting the absorbance value of the CZTS absorbent layer, the Light Harvesting Efficiency (LHE) value can be known. Observing the LHE value is to identify the amount of light successfully absorbed from the light shining on the CZTS absorber layer [31]. Based on Fig. 7, the average value of each sample has not reached 100%. This result indicated that it could not absorb light that perfectly illuminates the CZTS absorbent layer.

Table 2 shows that the absorbance and LHE values achieved by the 4-volt and 5-volt samples tend to be more stable than others. The highest LHE peak was reached in the 4 volt sample, but

in the 5 volt sample, the decrease in the LHE peak was not too far from the LHE peak in the 4 volt sample. This can be seen from the changes in absorbance and LHE values in the 4-volt and 5-volt samples, which are not so large compared to other samples.

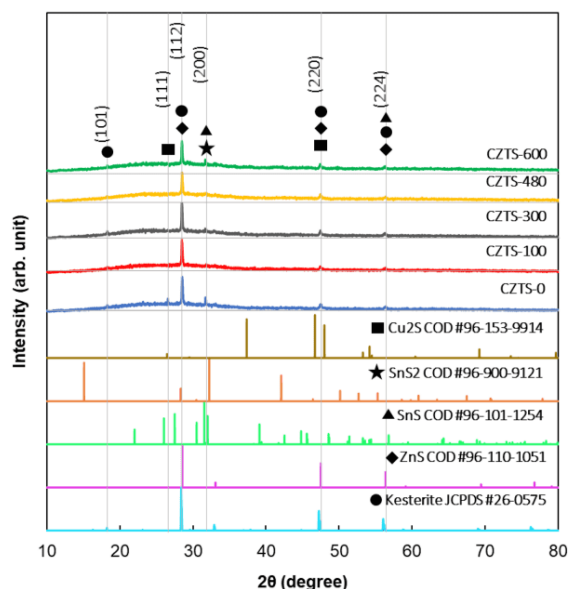

Fig. 6. XRD diffraction patterns show the formation of ZnS, Cu_2S , SnS, and SnS_2 as secondary phases

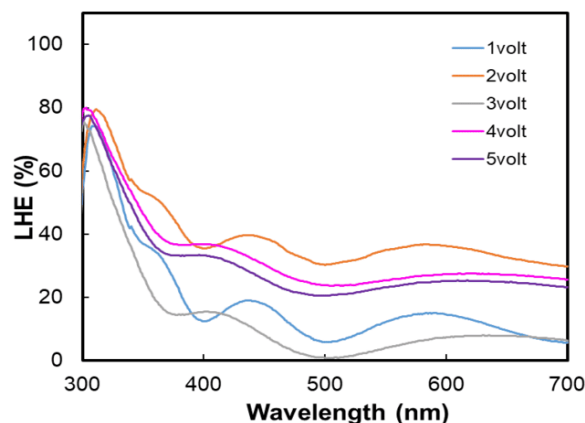

Fig. 7. Light Harvesting Efficiency (LHE)

After obtaining the absorbance value to determine the LHE value, the absorbance value can be used to determine the band gap value achieved by each sample of the CZTS absorbent layer.

Table 1. CZTS Crystal Size Using the Scherrer Equation

Sample	2θ	Intensity	FWHM	θ	Cos θ	D (nm)
1 volt	35.29	1000	0.20	17.64	0.95	7.29
2 volt	35.29	1000	0.20	17.64	0.95	7.29
4 volt	35.27	1000	0.20	17.63	0.95	7.29
5 volt	35.27	1000	0.24	17.63	0.95	6.07

Table 2. Light harvesting efficiency analysis

sample	LHE _{max} (%)	LHE (%)
1 volt	74.24	13.03
2 volt	79.58	33.07
3 volt	75.57	10.42
4 volt	79.98	27.82
5 volt	77.52	24.75

Absorbance data is processed and made into a graph using a Tauc plot. Based on Fig. 8. It is known that the bandgap value ranges from 1.41 to 1.48 eV. As mentioned in previous studies, this value was identified as a good characteristic of CZTS [17]. Furthermore, it is known that the difference in the value of the band gap in the sample increases at a larger deposition voltage. By analyzing the absorbance, LHE, and Band gap values of each sample, it is known that the changes in the values tend to increase along with the magnitude of the difference in the deposition voltage given to each sample. This shows that the deposition voltage on the electrochemical deposition method affects the optical characteristics of the CZTS absorbent sample, as shown in Table 3.

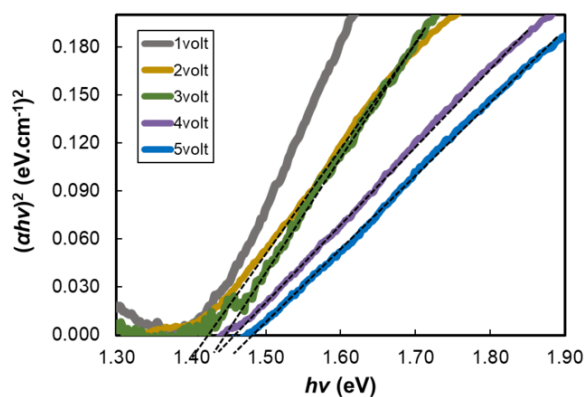

Fig. 8. Band Gap sample using Tauc-Plot

3.2. Device Performance

An efficiency test is carried out as a reference to determine the quality of solar cells. The intensity of sunlight and the temperature of solar radiation on solar cells are also essential factors in determining the efficiency of solar cells. Therefore, efficiency measurements must be carried out at standardized light and temperature.

Efficiency is done by measuring the current-voltage (I-V) as seen in Fig. 9. The data obtained can be used as a reference to determine parameters such as current density (J_{sc}), open circuit voltage (V_{oc}), and fill factor (FF) to determine the quality of solar cells. It is said that the solar cells are at maximum power (P_{max}) at conditions J_m and V_m . The efficiency test results are shown in Table 4. The highest efficiency value was achieved by 4 volts, but the 5-volt sample experienced a not-so-significant decrease.

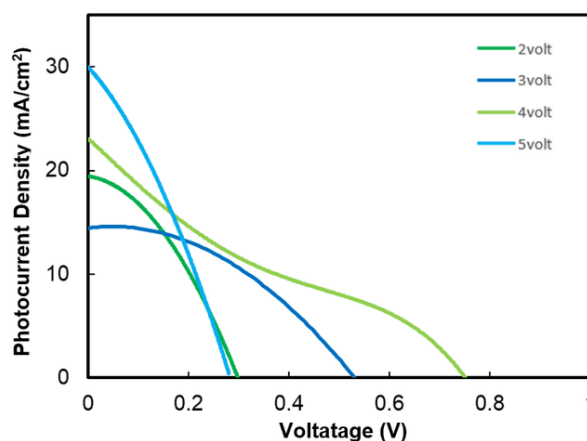

Fig. 9. I-V curves

In 2011, a study was conducted to determine the high efficiency of CZTS solar cells. The highest efficiency found in this study was 7.3% (Ahmed et al., 2012). This indicates that the efficiency of the 4-volt sample exceeds the reference efficiency, and the 5-volt sample matches the reference. The previous analysis found that the sample produces good LHE and Band gap values when applied with a higher deposition voltage. In addition, the small crystal size and good absorbance value support the CZTS solar cells' efficiency.

Table 3. The effect of deposition stress on the CZTS absorber layer

Samples	1 volt	2 volt	3 volt	4 volt	5 volt
Bandgap	1.40 eV	1.42 eV	1.45 eV	1.46 eV	1.48 eV
LHE _{max} %	74%	79%	75%	79%	77%

Table 4. Results of I-V curves data processing

Samples	Jsc (mA/cm ²)	Voc (V)	FF (%)	η (%)
2 volt	19.4	0.81	16.3	2.56
3 volt	14.9	0.65	34.7	3.36
4 volt	20.7	0.93	45.5	8.77
5 volt	28.3	0.85	32.1	7.72

4. CONCLUSIONS

From this research, it can be concluded that the effect of deposition stress on the electrochemical deposition method on the crystal structure of the CZTS absorbent layer is the difference in the crystal size of the CZTS material. The larger the applied deposition voltage, the smaller the resulting crystal size. The depositional stress also affects the kesterite phase, which appears more at higher depositional stresses. The effect of the deposition voltage on the electrochemical deposition method on the optical characteristics of the CZTS absorbing layer is that the band gap value tends to increase at a larger value of the deposition voltage. This applies to the LHE value, which has a greater value at a larger deposition voltage value. The effect of deposition voltage on the electrochemical deposition method on the performance of thin film solar cells based on the CZTS absorbent layer is the optimal efficiency generated at a given deposition voltage.

Acknowledgements

This work was supported by the Program Penelitian Terapan Unggulan Perguruan Tinggi, Kemendikbudristek, Republic of Indonesia 2023, Grant Number 1229/UN40. LP/PT.01 .03/2023.

REFERENCES

- [1]. Katagiri, H., K. Jimbo, W.S. Maw, K. Oishi, M. Yamazaki, H. Araki and A. Takeuchi, "Development of CZTS-based thin film solar cells." *Thin Solid Films*, 2009, 517, 2455-2460.
- [2]. Katagiri, H., K. Jimbo, M. Tahara, H. Araki and K. Oishi, "The influence of the composition ratio on CZTS-based thin film solar cells." *MRS Online Proceedings Library Archive*, 2009, 1165.
- [3]. Katagiri, H., K. Saitoh, T. Washio, H. Shinohara, T. Kurumadani and S. Miyajima, "Development of thin film solar cell based on Cu₂ZnSnS₄ thin films." *Solar Energy Materials and Solar Cells*, 2001, 65, 141-148.
- [4]. Nugroho, H.S., Refantero, G., Septiani, N.L.W., Iqbal, M., Marno, S., Abdullah, H., Prima, E.C. and Yulianto, B., "A progress review on the modification of CZTS (e)-based thin-film solar cells." *Journal of Industrial and Engineering Chemistry*, 2022, 105, 83-110.
- [5]. Huang, T.J., X. Yin, G. Qi and H. Gong, "CZTS-based materials and interfaces and their effects on the performance of thin film solar cells." *physica status solidi (RRL)–Rapid Research Letters*, 2014, 8, 735-762.
- [6]. Huang, W.-C., S.-Y. Wei, C.-H. Cai, W.-H. Ho and C.-H. Lai, "The role of Ag in aqueous solution processed (Ag, Cu) 2 ZnSn (S, Se) 4 kesterite solar cells: antisite defect elimination and importance of Na passivation." *Journal of Materials Chemistry A*, 2018, 6, 15170-15181.
- [7]. Aldalbahi, A., E. Mkawi, K. Ibrahim and M. Farrukh, "Effect of sulfurization time on the properties of copper zinc tin sulfide thin films grown by electrochemical deposition." *Scientific Reports*, 2016, 6, 32431.
- [8]. Shin, B., O. Gunawan, Y. Zhu, N.A. Bojarczuk, S.J. Chey and S. Guha, "Thin film solar cell with 8.4% power conversion efficiency using an earth-abundant Cu₂ZnSnS₄ absorber." *Progress in Photovoltaics: Research and Applications*, 2013, 21, 72-76.
- [9]. Nugroho, H.S., G. Refantero, E.C. Prima, C. Panatarani, Suyatman, N. Nugraha and B. Yulianto, "Crystal structure and optical properties of non-vacuum solution-based processed Cu₂ZnSnS₄ (CZTS) thin-film." *IOP Conference Series: Materials Science and Engineering*, 2021, 1045, 012039.
- [10]. Refantero, G., E.C. Prima, A. Setiawan, C. Panatarani, D. Cahyadi and B. Yulianto, "Etching process optimization of non-vacuum fabricated Cu₂ZnSnS₄ solar cell." *Journal of Materials Science: Materials in Electronics*, 2020, 31, 3674-3680.

- [11]. Ito, K. and T. Nakazawa, "Electrical and Optical Properties of Stannite-Type Quaternary Semiconductor Thin Films." Japanese Journal of Applied Physics, 1988, 27, 2094-2097.
- [12]. Liu, W.-S., S.-Y. Chen, C.-S. Huang, M.-Y. Lee and H.-C. Kuo, "Investigation of Zn/Sn ratio for improving the material quality of CZTS thin films with the reduction of Cu_{2-x}S secondary phase." Journal of Alloys and Compounds, 2021, 853, 157237.
- [13]. Aono, M., K. Yoshitake and H. Miyazaki, "XPS depth profile study of CZTS thin films prepared by spray pyrolysis." physica status solidi c, 2013, 10, 1058-1061.
- [14]. Moriya, K., K. Tanaka and H. Uchiki, "Fabrication of $\text{Cu}_2\text{ZnSnS}_4$ thin-film solar cell prepared by pulsed laser deposition." Japanese Journal of Applied Physics, 2007, 46, 5780.
- [15]. Prima, E.C., A. Vitadewi, A.D. Rahmat, E. Suhendi and B. Yulianto, "Solutions-Processed $\text{Cu}_2\text{ZnSnS}_4$ Solar Cell utilizing Zn Powder as Local Material." International Journal of Nanoelectronics & Materials, 2021, 14, 357-372.
- [16]. Lee, K.D., S.-W. Seo, D.-K. Lee, H. Kim, J.-H. Jeong, M.J. Ko, B. Kim, D.H. Kim and J.Y. Kim, "Preparation of $\text{Cu}_2\text{ZnSnS}_4$ thin films via electrochemical deposition and rapid thermal annealing." Thin Solid Films, 2013, 546, 294-298.
- [17]. Khattak, Y.H., F. Baig, H. Toura, I. Harabi, S. Beg and B.M. Soucase, "Single-step electrochemical deposition for the fabrication of CZTS kesterite thin films for solar cells." Applied Surface Science, 2019, 497, 143794.
- [18]. Toura, H., Y.H. Khattak, F. Baig, B.M. Soucase, M.E. Touhami and B. Hartiti, "Effect of complexing agent on the morphology and annealing temperature of CZTS kesterite thin films by electrochemical deposition." Current Applied Physics, 2019, 19, 606-613.
- [19]. Borate, H., A. Bhorde, A. Waghmare, S. Nair, P. Subhash, A. Punde, P. Shinde, P. Vairale, V. Jadkar and R. Waykar, "Single-step electrochemical deposition of CZTS thin films with enhanced photoactivity." ES Materials & Manufacturing, 2020, 11, 30-39.
- [20]. Farinella, M., R. Inguanta, T. Spanò, P. Livreri, S. Piazza and C. Sunseri, "Electrochemical deposition of CZTS thin films on a flexible substrate." Energy Procedia, 2014, 44, 105-110.
- [21]. Islam, M.F., N.M. Yatim and M.A. Hashim, "A review of CZTS thin film solar cell technology." Journal of Advanced Research in Fluid Mechanics and Thermal Sciences, 2021, 81, 73-87.
- [22]. Choubrac, L., A. Lafond, C. Guillot-Deudon, Y. Moëlo and S. Jobic, "Structure flexibility of the $\text{Cu}_2\text{ZnSnS}_4$ absorber in low-cost photovoltaic cells: from the stoichiometric to the copper-poor compounds." Inorganic chemistry, 2012, 51, 3346-3348.
- [23]. Brammertz, G., M. Buffière, S. Oueslati, H. ElAnzeery, K. Ben Messaoud, S. Sahayaraj, C. Köble, M. Meuris and J. Poortmans, "Characterization of defects in 9.7% efficient $\text{Cu}_2\text{ZnSnSe}_4\text{-CdS-ZnO}$ solar cells." Applied Physics Letters, 2013, 103, 163904.
- [24]. Gu, Y., X. Yin, J. Han, Y. Zhou, M. Tai, Q. Zhang, J. Li, X. Hao and H. Lin, "All Solution-Processed $\text{Cu}_2\text{ZnSnS}_4$ Solar Cell by Using High-Boiling-Point Solvent Treated Ball-Milling Process with Efficiency Exceeding 6%." ChemistrySelect, 2019, 4, 982-989.
- [25]. Boudaira, R., O. Meglali, A. Bouraiou, N. Attaf, C. Sedrati and M. Aida, "Optimization of sulphurization temperature for the production of single-phase CZTS kesterite layers synthesized by electrodeposition." Surface Engineering, 2020, 36, 1000-1011.
- [26]. Prima, E.C., L.H. Wong, A. Ibrahim and B. Yulianto, "Solution-processed pure $\text{Cu}_2\text{ZnSnS}_4\text{/CdS}$ thin film solar cell with 7.5% efficiency." Optical Materials, 2021, 114, 110947.
- [27]. Prawira, Y.Y., E.C. Prima, G. Refantero, H. Setyo and B.Y. Panatarani, "All-Solution-Non-Vacuum Fabrication Process of CZTS Solar Cell using ZTO as Non-Toxic Buffer Layer." International Journal of Nanoelectronics & Materials, 2020, 13, 307-314.
- [28]. Essaaidi, M. and Y. Zaz, Proceedings

- of 2014 International Renewable & Sustainable Energy Conference: (IRSEC'14). 2014: IEEE.
- [29]. Ziti, A., B. Hartiti, H. Labrim, S. Fadili, A. Ridah, B. Belhorma, M. Tahri and P. Thevenin, "Study of kesterite CZTS thin films deposited by spin coating technique for photovoltaic applications." *Superlattices and Microstructures*, 2019, 127, 191-200.
- [30]. Ziti, A., B. Hartiti, H. Labrim, S. Fadili, H.J. Tchognia Nkuissi, A. Ridah, M. Tahri and P. Thevenin, "Effect of copper concentration on physical properties of CZTS thin films deposited by dip-coating technique." *Applied Physics A*, 2019, 125, 1-9.
- [31]. Prima, E., A. Nuruddin, B. Yulianto, G. Kawamura and A. Matsuda, "Combined spectroscopic and TDDFT study of single-double anthocyanins for application in dye-sensitized solar cells." *New Journal of Chemistry*, 2018, 42, 11616-11628.