

EFFECTS OF Al-5Ti-1B MASTER ALLOY AND HEAT TREATMENT ON THE MICROSTRUCTURE AND DRY SLIDING WEAR BEHAVIOR OF AN Al-12Zn-3Mg-2.5Cu ALLOY

M. Alipour¹, S. Mirjavadi², M. K. Besharati Givi², H. Razmi¹, M. Emamy¹ and J. Rassizadehghani¹

* alipourmo@alumni.ut.ac.ir

Received: June 2012

Accepted: November 2012

¹ School of Metallurgy and Materials Engineering, University of Tehran, Tehran, Iran.

² School of Mechanical Engineering, College of Engineering, University of Tehran, Tehran, Iran.

Abstract: In this study the effect of Al-5Ti-1B grain refiner on the structural characteristics and wear properties of Al-12Zn-3Mg-2.5Cu alloy was investigated. The optimum amount for Ti containing grain refiners was selected as 2 wt.%. T6 heat treatment, (i.e. heating at 460 °C for 1 h before water quenching to room temperature and then aging at 120 °C for 24 h) was applied for all specimens before wear testing.

Dry sliding wear resistant of the alloy was performed under normal atmospheric conditions. The experimental results showed that the T6 heat treatment considerably improved the resistance of Al-12Zn-3Mg-2.5Cu alloy to dry sliding wear.

Keywords: Casting, Heat treatments, Microstructure, Grain size, Wear properties, Dry sliding test.

1. INTRODUCTION

Al-Zn-Mg-Cu alloys are widely used in many industrial applications because of their low density and high strength [1]. These alloys are heat treatable and show attractive properties where good combination of strength and stiffness are obtained particularly after T6 heat treatment [2-4]. Super high strength aluminum alloys have been extensively studied after mechanical deformation for decades [5-7], but little attention has been made on as-cast alloys and their resistance to degradation in some corrosive environments. As-cast structures of these alloys have a significant influence on their mechanical properties and the quality of finished products [8]. The structure of such materials can be controlled by some important factors such as: changing the composition, adding grain refining

agents, minimizing inclusions and applying thermomechanical treatments [9]. The use of high concentrations of alloying elements results in homogeneity in the microstructure and severe segregation of second phases. In casting products, the mechanical properties vary from location to location due to the variation of grain size, the amount of eutectic phases and the amount of precipitates. Much attention has been made to reduce the segregation of the alloying elements during solidification period of high-alloyed Al alloys [5, 10].

However, they often suffer severe damage under the synergistic attack of wear and corrosion in some aggressive media, regardless of their good corrosion resistance [11]. Since poor tribology performance limits the use of aluminum and its alloys in wear related applications, many efforts including modification

Table 1. Chemical composition of the primary ingots (wt.%).

Al	Zn	Mg	Cu	Ti	B	Fe	Si
Rem.	12.24	3.24	2.46	-	-	0.16	0.03

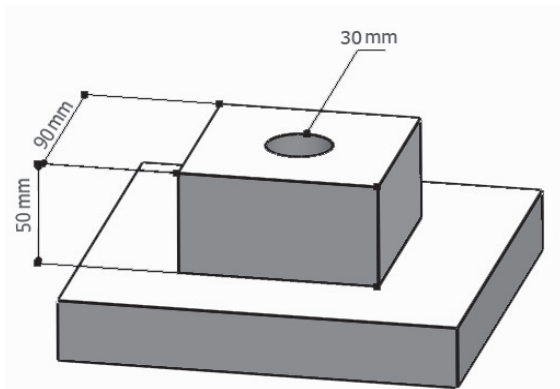

Fig. 1. Schematic drawing of casting mould specimen.

of bulk [12,13] and surface properties [14–30] have been made to improve their wear and corrosion wear resistance.

This present investigation aims to study the effect of Al–5Ti–1B and heat treatment on the microstructure and dry sliding wear behavior of Al–12Zn–3Mg–2.5Cu aluminum alloy.

2. EXPERIMENTAL PROCEDURE

The chemical composition of Al–12Zn–3Mg–2.5Cu alloy studied in this work is given in Table 1. Melting of 10 kg of the alloy was carried out in an electrical resistance furnace using a SiC crucible. Industrially pure elemental Al (99.87%), Mg (99.99%), Zn (99.996) and Cu (99.9%) were used as starting materials to prepare the primary ingots. Then the chopped ingots were remelted in a small electrical resistance furnace (with accurate temperature measuring system, ± 5 °C) in order to prepare alloys with different amounts of Ti. Degassing was conducted by submerging dry C_2Cl_6 containing broken tablets (0.3 wt.% of the molten alloy). Then 2 wt.% of Al–5Ti–1B grain refiner was added to the melt at 750 °C. After stirring with a graphite rod for about 1 min and cleaning off the dross, the melt was poured into a cast iron mould (Fig. 1) at 720 °C. After a period of about 5 min, the molten alloy was poured into the mould. For microstructural studies, samples were selected from 20 mm of the bottom of each casting.

The cut sections were polished and then etched

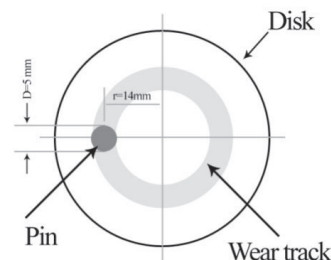

Fig. 2. Schematic of pin-on-disk configuration.

by Keller’s reagent (2 ml HF, 3 ml HCl, 5 ml HNO_3 and 190 ml H_2O) to reveal the microstructure. The average grain size of the specimens was measured according to the ASTM E-12 standard [31]. T6 heat treatment (solution treatment at 450 °C for 1 h, followed by quenching in water and finally aging at 120 °C for 24 h) applied for all casting samples. Then, cylindrical samples were machined to obtain pin of 5 mm in diameter and 15 mm in height.

Dry sliding wear tests were conducted using a conventional pin-on-disk testing machine to appraise room temperature (i.e., 25 °C) wear behavior of the Al–12Zn–3Mg–2.5Cu alloy against a DIN 100Cr6 steel disk with a hardness of 62HRC. The pins, 5 mm×14 mm, were in a conformal contact with the steel disk. Figure 2 shows the schematic of the pin-on-disk configuration used in this study. The unrefined and refined aluminum alloy by Al–5Ti–1B were tested at a rotational speed of 247 rpm, corresponding to a speed of 0.5 ms^{-1} , under nominal load of 40N for a sliding distance of 1500 m. The weight of the specimens was measured before and after the wear test using an electronic balance (GR200-AND) with an accuracy of 0.1 mg.

For the worn surfaces studies and structural studies optical microscope equipped with an image analysis system (Clemex Vision Pro. Ver.3.5.025) have been used and scanning electron microscopy (SEM) performed in a Cam Scan MV2300 SEM, equipped with an energy dispersive X-ray analysis (EDX) accessory.

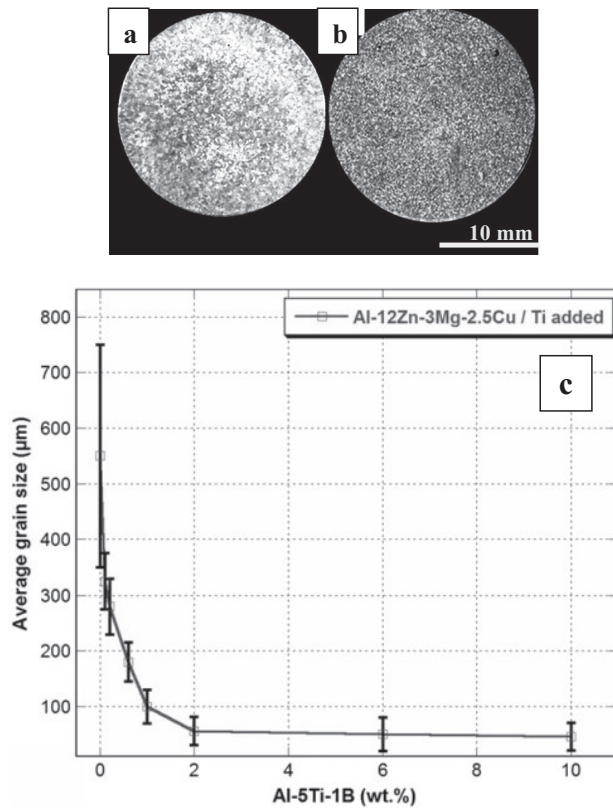

Fig. 3. Macrographs of (a) un-refined alloy, (b) Ti refined alloy, (c) Grain size variation with Ti contents.

3. RESULTS AND DISCUSSION

3. 1. Microstructural Studies

Figure 3a–b shows the macrostructures of the Al–12Zn–3Mg–2.5Cu alloy in unrefined and refined specimens with optimum amount Ti concentrations. It can be seen that even in unrefined conditions, the alloy presents a fully equiaxed grain structure.

Fig. 3c shows the effect of various amounts of Al–5Ti–1B grain refiner on the average grain size of the cast specimens. It can be seen that the increase of Al–5Ti–1B master alloy from 0.1 to 2 wt.% in the alloy can result in a fine microstructure and almost significant reduction of the average grain size. However, by further addition of grain refiner (>2 wt.%) to the alloy, the average grain size almost remains constant and the excess addition of the grain refiner does not have a considerable effect on the macrostructure of the alloy.

The study of refined specimens showed the presence of different microstructural features, which may result in different mechanical properties. Thus, it was necessary to find a suitable level of the applied refiners in order to obtain an appropriate combination of refined structure and optimized mechanical properties. For this purpose, a series of microscopic studies was made to determine the optimum level of refiner can be used in order to maintain the uniformity of the matrix acceptable. The optimum amounts of Ti was determined to be 0.1 wt.%.

Several mechanisms have been proposed for the grain refining process [32]. The presence of some particles like $TiAl_3$, TiB_2 and AlB_2 are known to be effective for grain refinement while $TiAl_3$ is known to be a potent nucleating site for aluminum [32–34]. Jones and Pearson [35] have demonstrated that a ternary Al–Ti–B grain refiner is 4–5 times more efficient than a binary Al–Ti grain refiner having approximately the same titanium content, in terms of the decrease in grain size.

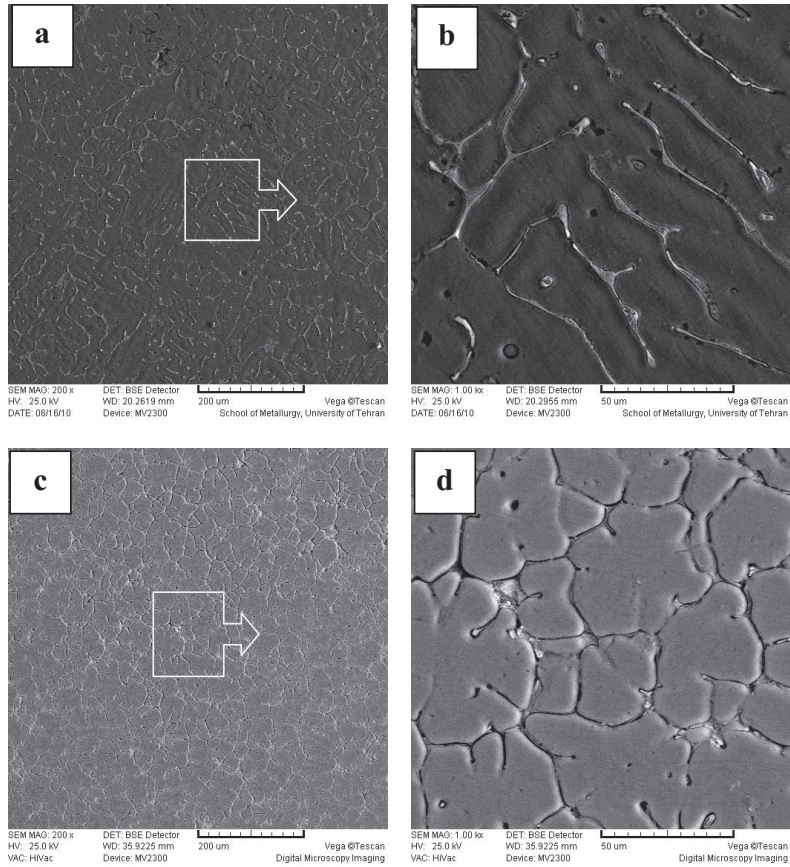

Fig. 4. SEM micrographs of (a-b) unrefined specimen, (c-d) 0.1% Ti-refined specimen.

With high concentrations of alloying elements (Zn, Cu, and Mg) in Al-12Zn-3Mg-2.5Cu alloy, severe segregation is expected in as-cast condition. The segregation of solute occurred during solidification of the alloy led to the high concentration of Cu, Mg and Zn in the interdendritic eutectic regions. The most common phases observed in as-cast microstructure in the

Al-Zn-Mg-Cu alloys are η -MgZn₂ (as a part of eutectic structure), T-Al₂Mg₃Zn₃ and S-Al₂-CuMg [1].

Figure 4a–b shows SEM back scattered images of the alloy in as-cast condition without and with Ti addition. It is noticeable that grain refinement by 0.1 wt.% Ti enhances the number of grain boundaries and promotes a more homogeneous

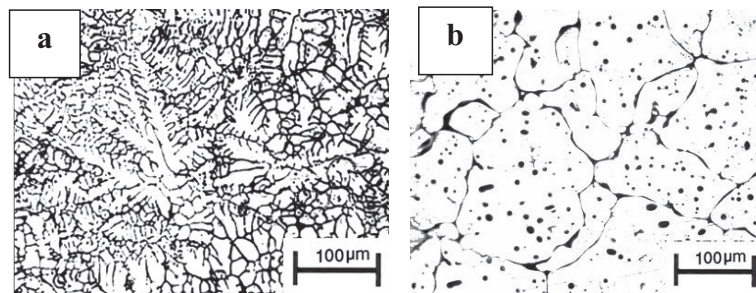

Fig. 5. Microstructures of unrefined specimens in (a) as cast and (b) heat treated (T6) conditions.

distribution of intermetallic compounds and eutectic structure.

The microstructures of Al-12Zn-3Mg-2.5Cu alloy contains highly primary α -phase (solid solution of aluminum) and second phases based on η (in eutectic region), S and T phases. Figure 4 shows the change in dendrite morphology of the Al-12Zn-3Mg-2.5Cu alloy after grain refinement addition. The optical microstructures of Ti refined alloy revealed a rosette-like

microstructure of primary α -Al grains solid solution surrounded by inter-dendritic secondary phases. From figure 5, it is noticeable that grain refinement enhances the number of grain boundaries and therefore promotes a more homogeneous distribution of intermetallic precipitates. The most common phases observed in as-cast microstructure in the Al-Zn-Mg-Cu alloys are η -MgZn₂ (as a part of eutectic structure), T-Al₂Mg₃Zn₃, S-Al₂CuMg [36, 37].

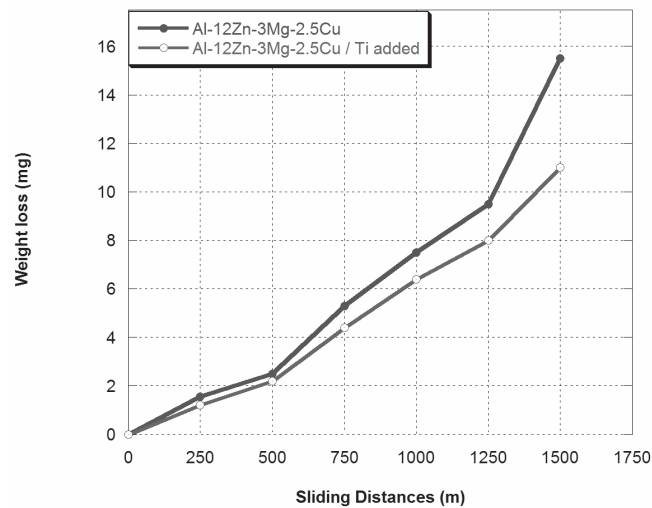

Fig. 6. Weight loss as a function of sliding distance for unrefined and 0.1% Ti-refined specimens.

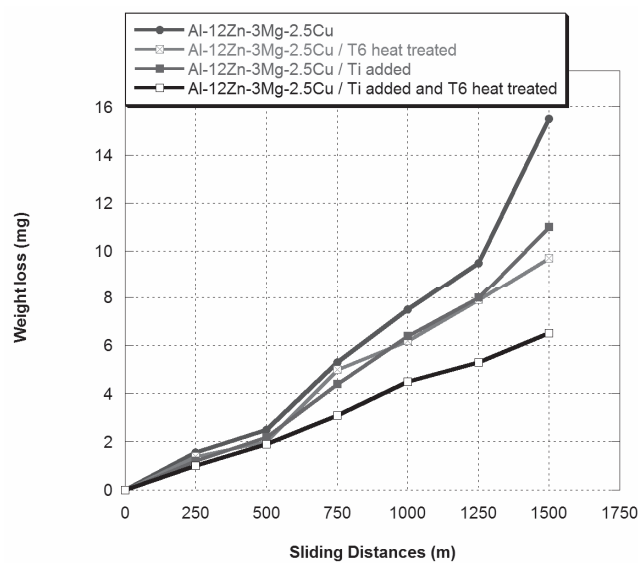

Fig. 7. Weight loss as a function of sliding distance for unrefined and 0.1% Ti-refined specimens with and without heat treatment.

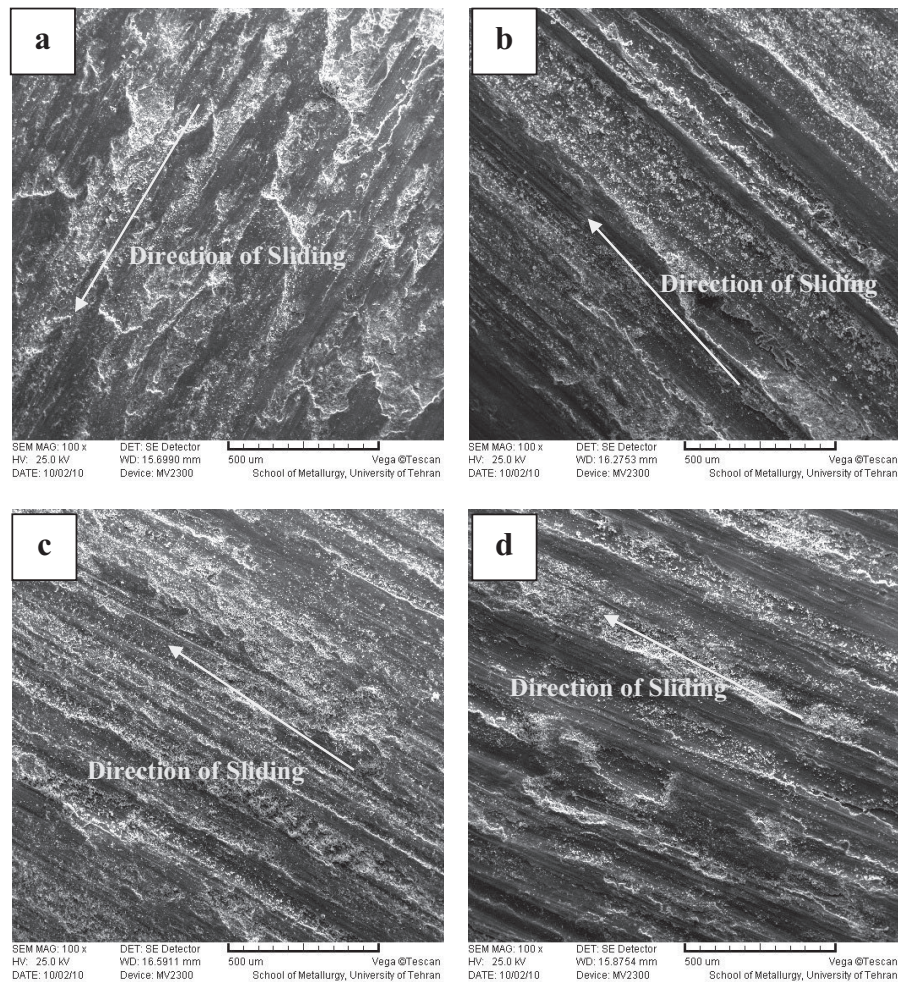

Fig. 8. Wear surface of the materials after 1500 m distance with 40 N load during wear process of (a) unrefined, (b) unrefined with T6 heat treated, (c) refined by 0.1 wt.% Ti, (d) refined by 0.1 wt.% Ti with T6 heat treatment.

3. 2. Effect of Al-5Ti-1B Addition on Wear Behavior

The wear results for Al-12Zn-3Mg-2.5Cu alloy with similar Ti content (0.1 wt.%) are shown in figures 6 and 7. Figure 7 shows the amount of weight loss against sliding distance. This diagram was obtained at a constant normal load (40 N) and a constant rotation speed of the counter disk (225 rpm). It can be seen in this figure that the amount of weight loss has increased by increase in sliding distance. Furthermore, increase in the amount of weight loss with sliding distance, approximately has a linear trend.

Comparison between heat treated modified

and unmodified Al-12Zn-3Mg-2.5Cu alloys is shown in figure 7. From figure 7, it is clear that the addition of Ti to Al-12Zn-3Mg-2.5Cu alloy has reduced the weight loss in comparison with unrefined aluminum alloy. This can be described in terms of uniform distribution of secondary phase in refined heat treated alloy by addition of 0.1 wt.% Ti (figure 4(c-d)).

It is interesting to note that, the Weight loss of the T6-tempered alloy was generally lower than those of untreated alloys in dry sliding wear tests.

Wear surfaces of unrefined and refined by 0.1 wt.% Ti with and without heat treatment are shown in figure 8. It can be seen a mild wear regime grooves the wear mechanism of the all alloys in figure 8. It clearly shows plastic

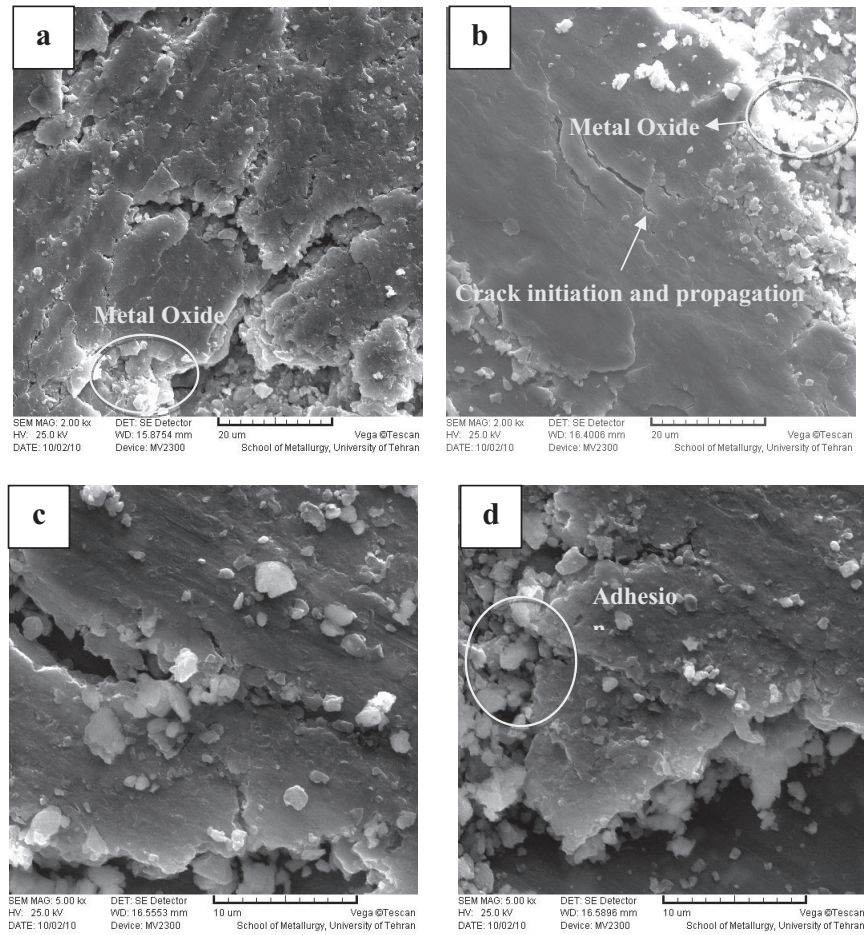

Fig. 9. SEM micrographs of the worn surfaces of Al-12Zn-3Mg-2.5Cu aluminum alloys (sliding distance 1500 m). (a) unrefined, (b) unrefined with T6 heat treated, (c) refined by 0.1 wt.% Ti, (d) refined by 0.1 wt.% Ti with T6 heat treatment.

deformation and delamination characteristics.

Metal oxides and microcrack in wear surfaces are evident in figure 9a-d. Wear scars formed by adhesion are evident in figure 9a-b with the adhesion being more obvious in the latter.

It seems that during the early stages of sliding, delamination wear was the dominant mechanism for the unrefined and refined by 0.1 wt.% Ti with and without T6 heat treatment.

For unrefined Al-12Zn-3Mg-2.5Cu alloys with coarse dendritic morphology can be easily broken and contribute to the weight loss.

4. CONCLUSIONS

Wear properties of Al-12Zn-3Mg-2.5Cu

alloys by addition of 0.1% Ti investigated using a pin-on-disk method. Followings were concluded:

1. Al-5Ti-1B was effective in reducing the grain size, altering dendritic morphology and introducing fine and uniform microstructure.
2. Grain refining by 1 wt.% Al-5Ti-1B and T6 heat treatment improve the microstructure and wear resistant.
3. The weight loss of aluminum alloy increased with increase in distance.
4. All wear surfaces showed plasticity deformation, delamination and adhesion characteristics with one being dominant in each aluminum alloy with and without T6 heat treatment.

ACKNOWLEDGEMENT

The authors would like to thank University of Tehran for financial support of this research.

REFERENCES

1. Fan, X., Jiang, D., Meng, Q., Zhong, L., The microstructural evolution of an Al–Zn–Mg–Cu alloy during homogenization. *Mater. Lett.*, 2006, 60, 1475.
2. Tao, W., Zhi-min, Y., Kai, S., Jie, L., Ji-wu, H., “Single-aging characteristics of 7055 aluminum alloy.” *Trans Nonferrous Met Soc China* 2007;17:548–52.
3. Buha, J., Lumley, R. N., Crosky, A. G., “Secondary ageing in an aluminum alloy 7050.” *Mater Sci Eng A* 2008;492:1–10.
4. Dixit, M., Mishra, R. S., Sankaran, K. K., “Structure-property correlations in Al 7050 and Al 7055 high-strength aluminum alloys.” *Mater Sci Eng A* 2008;478:163–72.
5. Dong, J., Cui, J. Z., Yu, F. X., Zhao, Z. H., Zhuo, Y. B., “A new way to cast high-alloyed Al–Zn–Mg–Cu–Zr for super-high strength and toughness.” *J Mater Process Technol* 2006;171:399–404.
6. Li, Y., Li, P., Zhao, G., Liu, X., Cui, J., “The constituents in Al–10Zn–2.5Mg–2.5Cu aluminum alloy.” *Mater Sci Eng A* 2005;397:204–8.
7. Wang, F., Xiong, B., Zhang, Y., Zhu, B., Liu, H., Wang, Z., “Microstructure and mechanical properties of spray-deposited Al–10.8Zn–2.8Mg–1.9Cu alloy after two-step aging treatment at 110 and 150 °C.” *Mater Charact* 2007;58:82–6.
8. Zhang, B., Cui, J., Lu, G., “Effects of low-frequency electromagnetic field on microstructures and macrosegregation of continuous casting 7075 aluminum alloy.” *Mater Sci Eng A* 2003;355:325–30.
9. Srivatsan, T. S., Sriram, S., “Microstructure, tensile deformation and fracture behaviour of a aluminum alloy 7055.” *J Mater Sci* 1997;32:2883–94.
10. Dong, J., Cui, J. Z., Yu, F. X., Ban, C., Zhao, Z. H., “Effect of low-frequency magnetic casting on the castability microstructure and tensile properties of direct-chill cast Al–Zn–Mg–Cu alloy.” *Metall Mater Trans A* 2004;35:2487–94.
11. Zhang, T., Li, D. Y., “Improvement in the resistance of aluminum with yttria particles to sliding wear in air and in a corrosive medium.” *Wear* 2001;251:1250–6.
12. Sun, Y., Baydogan, M., Cimenoglu, H., “The effect of deformation before ageing on the wear resistance of an aluminium alloy.” *Mater Lett* 1999;38:221–6.
13. Dutkiewicz, J., Litynska, L., “The effect of plastic deformation on structure and properties of chosen 6000 series aluminium alloys.” *Mater Sci Eng, A* 2002;324:239–43.
14. Zandrahimi, M., Rezvanifar, A., “The Influence of Dry Sliding on Precipitation Hardening Behaviors of Al-Cu-Si Alloys.” *IJMSE* 2012, 9(1): 42-50
15. Rezvanifar, A., Zandrahimi, M., “Evaluation of Dislocation Structure and Crystallite Size in Worn Al-Si Alloy by X-RAY Diffraction.” *IJMSE* 2010, 7(1): 32-38
16. Akhlaghi, F., Zahedi, H., Sharifi, M., “Effects of Reinforcement Volume Fraction, Reinforcement Size and Solution Heat Treatment on the Microstructure of the Two Differently Processed A35 & Sicpcomposites.” *IJMSE* 2004, 1(2): 9-15
17. Czerwiec, T., Renevier, N., Michel, H., “Low-temperature plasma- assisted nitriding.” *Surf Coat Technol* 2000;131:267–77.
18. Sun, J., Weng, L., Xue, Q., “Duplex treatment for surface improvement of 2024 Al.” *Vacuum* 2001;62:337–43.
19. Man, H. C., Zhang, S., Yue, T. M., Cheng, F. T., “Laser surface alloying of NiCrSiB on Al6061 aluminum alloy.” *Surf Coat Technol* 2001;148:136–42.
20. Okumiya, M., Tsunekawa, Y., Murayama, T., “Surface modification of aluminum using ion nitriding and fluidized bed. *Surf Coat Technol* 2001;142–144:235–40.
21. Edrisy, A., Perry, T., Cheng, Y. T., Alpas, A. T., “Wear of thermal spray deposited low carbon steel coatings on aluminum alloys.” *Wear* 2001;251:1023–33.
22. Tomida, S., Nakata, K., Saji, S., Kubo, T., “Formation of metal matrix composite layer on aluminum alloy with TiC–Cu powder by

- laser surface alloying process.” *Surf Coat Technol* 2001;142–144:585–9.
23. Harada, Y., Mori, K., Maki, S., “Lining of light metals with hard powders using shot peening.” *J Mater Process Technol* 2002;125–126:525–31.
 24. Nakata, K., Ushio, M., “Effect of Fe content on wear resistance of thermal-sprayed Al–17Si–XFe alloy coating on A6063 Al alloy substrate.” *Surf Coat Technol* 2003; 169–170:443–6.
 25. Tomida, S., Nakata, K., “Fe–Al composite layers on aluminum alloy formed by laser surface alloying with iron powder.” *Surf Coat Technol* 2003;174–175:559–63.
 26. Yang, S., Chen, N., Liu, W., Zhong, M., “In situ formation of MoSi₂ / SiC composite coating on pure Al by laser cladding.” *Mater Lett* 2003;57:3412–6.
 27. Nagae, T., Tomida, S., Okada, A., Inada, N. “Surface modification of A2014 Al alloy using a pulse current pressure sintering process.” *Surf Coat Technol* 2003;169–170:174–7.
 28. Balbyshev, V. N., King, D. J., Khramov, A. N., Kasten, L. S., Donley, M. S., “Investigation of quaternary Al-based quasicrystal thin films for corrosion protection.” *Thin Solid Films* 2004;447–448:558–63.
 29. Kiper, G., Mindivan, H., Samur, R., Cimenoglu, H., Kayali, E. S., “Tribological behaviour of steel coatings deposited on aluminum. *Aimeta International Tribology Conference*,” 2004, Rome, Italy.
 30. AkVn, U., Mindivan, H., Kayali, E. S., Cimenoglu, H., “Tribological behaviour of combined coatings deposited on aluminum.” *Key Eng Mater* 2005;280–283:1453–8.
 31. Annual book of ASTM standards. American Society for Testing of Metals, vol. 0.3.0.1; 1994.
 32. Murty, B. S., Kori, S. A., Chakraborty, M., “Grain refinement of aluminium and its alloys by heterogeneous nucleation and alloying.” *Int Mater Rev* 2002;47:3–29.
 33. Quested, T. E., Greer, A. L., “The effect of the size distribution of inoculant particles on as-cast grain size in aluminum alloys.” *Acta Mater* 2004;52:3859–68.
 34. Rokhlin, L. L., Dobatkina, T. V., Bochar, N. R., Lysova, E. V., “Investigation of phase equilibria in alloys of the Al–Zn–Mg–Cu–Zr–Sc system.” *J Alloys Compd* 2004;367:10.
 35. Jones, G. P., Pearson, J., “Factors affecting grain refinement of aluminum using Ti and B additives.” *J Metall Trans B* 1976;7B:223–34.
 36. Fan, X., Jiang, D., Meng, Q., Zhong, L., “The microstructural evolution of an Al–Zn–Mg–Cu during homogenization.” *Mater Lett* 2006;60:1475–9.
 37. Mondal, C., Mukhopadhyay, A. K., “On the nature of T(Al₂Mg₃Zn₃) and S(Al₂CuMg) phases present in as-cast and annealed 7055 aluminum alloy.” *Mater Sci Eng A* 2005;391:367.